

Breville®



Halo+ health fryer

selection of recipes included

Here to help...



0161 621 6900



enquiriesEurope@jardencs.com



www.breville.co.uk



www.breville.co.uk/faqs

Find Breville UK at...



YouTube

For hints, tips and over 200 recipes, visit...

creative
kitchen

www.brevillecreativekitchen.co.uk

product safety

READ CAREFULLY AND KEEP FOR FUTURE REFERENCE

This appliance shall not be used by children from 0 year to 8 years. This appliance can be used by children aged from 8 years and above if they are continuously supervised. This appliance can be used by people with reduced physical, sensory or mental capabilities or lack of experience and knowledge if they have been given supervision or instruction concerning use of the appliance in a safe way and understand the hazards involved.

Keep the product and its cord out of reach of children aged less than 8 years. Cleaning and user maintenance must not be done by children.

This product must be positioned on a stable surface with the handles positioned to avoid the spillage of hot liquids.

Surfaces of the product are liable to get hot during use.

Never operate the product by means of an external timer or separate remote-control system.

If the supply cord is damaged, it must be replaced by the manufacturer, its service agent or similarly qualified persons in order to avoid a hazard.



- ⚠ Never use this appliance for anything other than its intended use. This appliance is for household use only. Do not use this appliance outdoors.
- ⚠ Always ensure that hands are dry before handling the plug or switching on the appliance.
- ⚠ Always use the appliance on a stable, secure, dry and level surface.
- ⚠ Ensure the appliance is switched off and unplugged from the supply socket if it is left unattended, when it is not in use or before cleaning. Never leave the appliance unattended when it is in use.
- ⚠ Always allow the appliance to fully cool down before cleaning or storing.
- ⚠ Do not use the appliance if it has been dropped, if there are any visible signs of damage or if it is leaking.
- ⚠ Never immerse any part of the appliance or power cord and plug in water or any other liquid.
- ⚠ Never let the power cord hang over the edge of a work top, touch hot surfaces or become knotted, trapped or pinched.
- ⚠ Do not touch the external surfaces of the appliance during use as they may become very hot.
- ⚠ Only use spares or accessories that are recommended by the manufacturer.
- ⚠ When the appliance is in the tilted position, the lid will not stay open on its own. Always return the appliance to the level position before opening the lid.
- ⚠ Allow adequate space above and on all sides for air circulation.
- ⚠ Do not allow the appliance to touch any flammable material during use (such as curtains or wall coverings).
- ⚠ Care is required when using the appliance on surfaces that may be damaged by heat. The use of an insulated pad is recommended.

parts

1. Lid - removable for cleaning
2. Heater and fan assembly
3. Lid cleaning release button (one on each side)
4. Lid latch button
5. Removable condensation tray
6. Tilt mechanism lock and window
7. Icon for tilted position
8. Icon for level position
9. + (increase time) button
10. – (decrease time) button
11. Display
12. Dual heat mode button
13. Grill button
14. Non-stick inner bowl
15. Roasting rack
16. Oil measure  (approximately equal to 15ml)
17. Detachable bowl handle

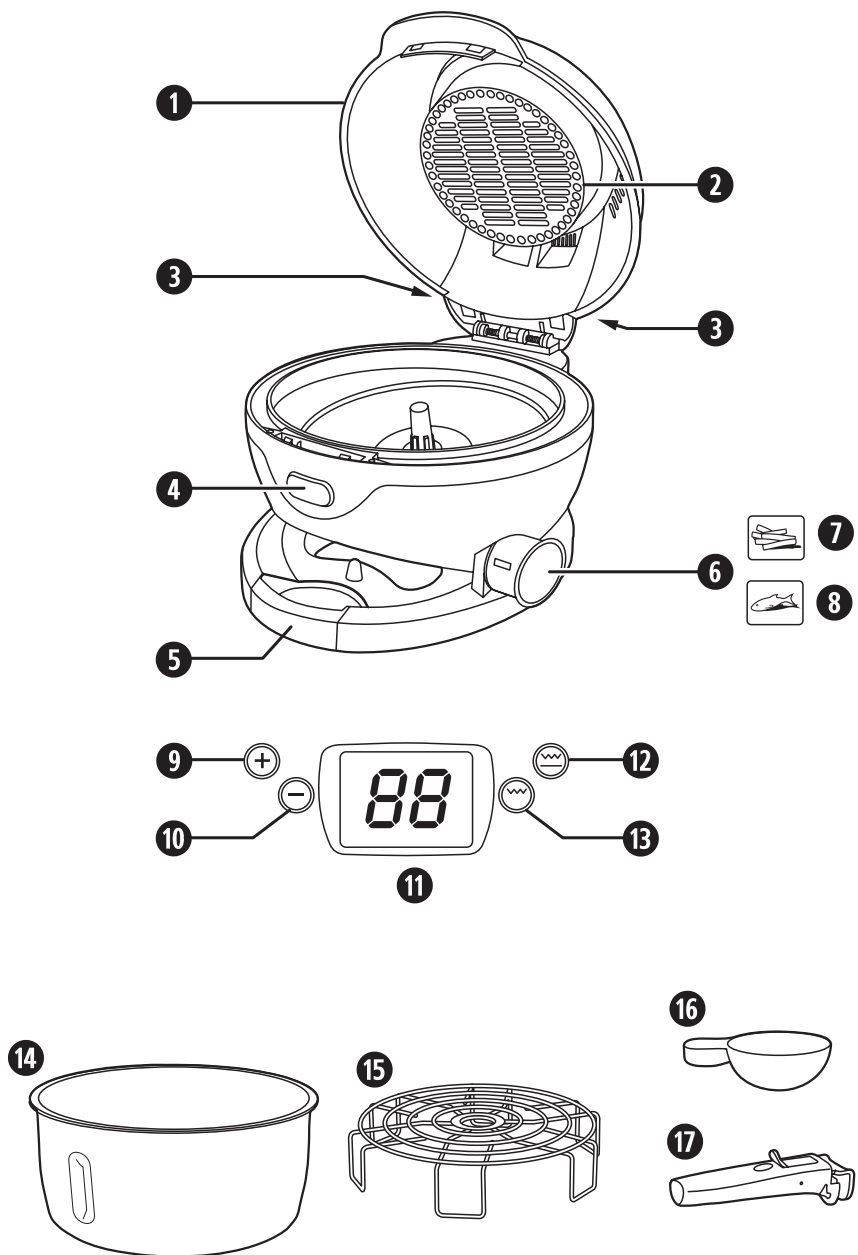

Due to our policy of continuous improvement, the actual product may differ slightly from the one illustrated in these instructions.



⚠ Never immerse any part of the Halo+ Health Fryer body, power cord or plug in water or any other liquid. Before assembling or disassembling your Halo+ Health Fryer, ensure it is unplugged and all parts are cool.

Unpack the appliance and remove all packaging, promotional materials and stickers. Remove all printed documents. Wash the inner bowl, measuring spoon, roasting rack, drip tray and bowl handle in hot soapy water. Rinse then dry all of the parts. Wipe the body and lid with a damp cloth only—see page 16 for cleaning instructions.



▲ Only use the handle to remove the bowl after cooking has finished. Remember the bowl will be very hot! Don't set the bowl down on a surface that may be damaged by heat.

After cooking, you can use the detachable bowl handle to remove the inner bowl and its contents safely.

1. Make sure that the jaws of the handle are open. Press the button on the handle to open the jaws if required.
2. Place the bowl handle over the lip of the inner bowl
3. Slide the lever forwards. The handle will grip the inner bowl. Let the lever return to its rest position.
4. Lift the inner bowl out of the Halo+ Health Fryer body.
5. To release the bowl, press the button on the handle.
6. Lift the handle off the rim of the bowl.

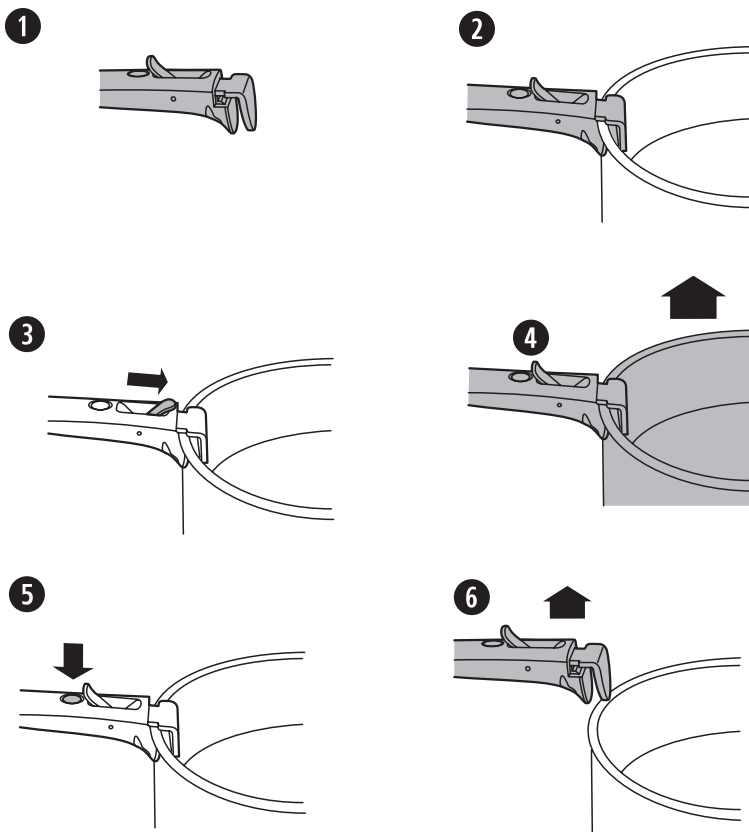



cooking chips

⚠ WARNING: When your Halo+ Health Fryer is in the tilted position, the lid will not stay open on its own and may close unexpectedly. Always return the appliance to the level position before opening the lid.

Your Halo+ Health Fryer can be used to cook fresh or frozen chips, however, for the healthiest option, we suggest you try our perfect homemade chips on page 18.

1. Press the lid latch button and open the lid.
2. Fit the inner bowl over the central shaft.
3. Add the chips to the bowl. Distribute the chips evenly over the bottom of the bowl. Don't exceed 1.25kg of fresh chips or 1.0kg frozen chips.
4. Add the recommended quantity of oil to the chips using the cooking oil measure. Spread the oil evenly over the chips. Please refer to our cooking popular, convenience and frozen foods guide on page 14-15.
5. Close the lid and plug your Halo+ Health Fryer into a suitable mains supply and switch the socket on. Your Halo+ Health Fryer will beep, the display will light up blue and after a second or two will show **00**.
6. Use the **+** button to enter the desired cooking time in minutes. If you keep your finger on the **+** button, the time will increase quickly. When you are near the desired time, make single presses of the button. If you overshoot the desired time, use the **-** button to adjust the time.

Next, pull the tilt mechanism lock outwards and tilt your Halo+ Health Fryer forwards. Release the tilt lock to lock your Halo+ Health Fryer in the fully tilted position. When in the correct position, the  icon will show in the window of the tilt lock.



7. Press the dual heat mode () button to start cooking. The display will turn orange, the heater will illuminate and the fan will start. The timer will start to count down in minutes until 1 minute remains when it will count down in seconds.
8. When the cooking time has ended, your Halo+ Health Fryer will beep and the heater will turn off.

Notes

The cooking time can be adjusted up or down during cooking using the **+** or **-** buttons.

During cooking, you may open the lid if required. First, set your Halo+ Health Fryer to the level position then press the lid release button. Opening the lid will switch off the heater and the fan, and the timer will stop counting down. To restart cooking, close the lid then return your fryer to the tilted position. Cooking will resume when you close the lid and the timer will continue to count down.

During cooking, the heater will switch on and off from time to time. This is normal and allows your Halo+ Health Fryer to maintain an even cooking temperature.

You can cancel cooking at any time by pressing and holding either the dual heat mode () button **or** the grill mode () button. Your Halo+ Health Fryer will beep, the display will return to **00** and cooking will be cancelled.

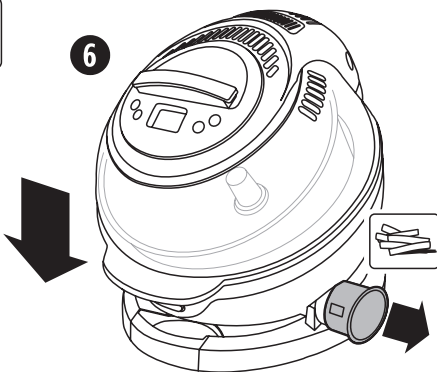
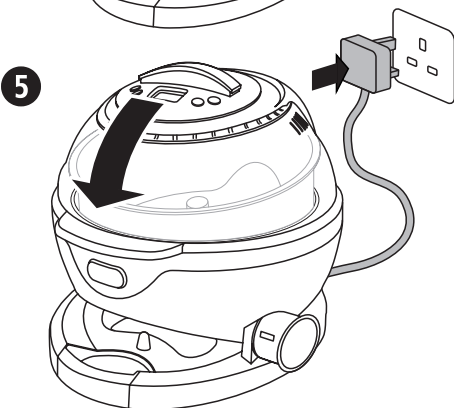
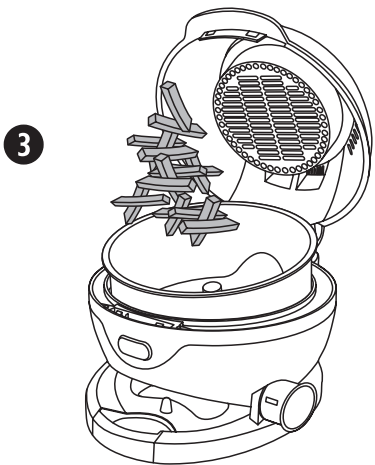
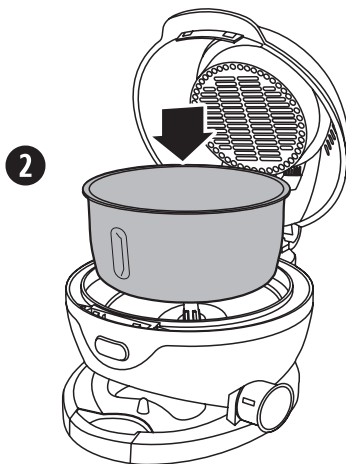
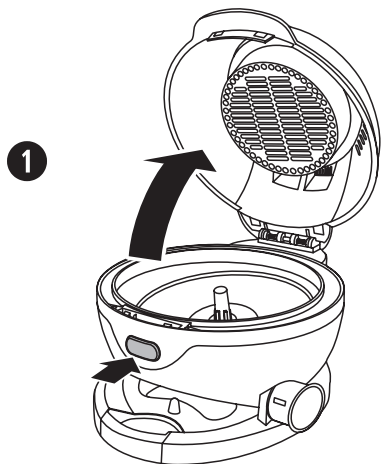



other cooking methods

Grilling

Your Halo+ Health Fryer comes complete with a dishwasher safe rack suitable for grilling and other types of cooking. Foods can also be cooked directly in the removable bowl. Use whichever method gives you the best results.

1. Press the release button and open the lid. Place the rack into the inner bowl. For best results lightly oil the rack before use.
2. Place the food on the rack (if you are using it). Select the cooking time, then the grill function. The rack and food will rotate during cooking so make sure that the food will not touch any part of the heater/fan assembly or other part of the lid when it is closed.
3. If required, add oil evenly over the food.
4. Close the lid and plug your Halo+ Health Fryer into a suitable mains supply and switch the socket on. Your Halo+ Health Fryer will beep, the display will light up blue and after a second or two will show .
5. Use the **+** button to enter the desired cooking time in minutes. If you keep your finger on the **+** button, the time will increase quickly. When you are near the desired time, make single presses of the button. If you overshoot the desired time, use the **-** button to adjust the time.

When grilling, your Halo+ Health Fryer should be in the level position (the  icon will show in the window of the tilt lock).

6. Press the grill mode  button to start cooking. The display will turn orange, the heater will illuminate and the fan will start. The timer will start to count down in minutes until 1 minute remains when it will count down in seconds.
7. When the cooking time has ended, your Halo+ Health Fryer will beep and the heater will turn off.

Notes

This product has been designed to cook foods in a healthier way. We do not recommend that you use your Halo+ Health Fryer to cook foods which are very fatty e.g. chicken portions (with the skin on), lamb chops, sausages or other fatty cuts of meat.

Dual Heat cooking mode without tilting

To tilt or not to tilt...

Your Halo+ Health Fryer can be used to cook the foods and recipes that you would normally cook in a standard oven or saucepan. However, when your Halo+ Health Fryer is tilted, the food inside is 'tumbled' which may damage fragile foods such as salmon, jacket potatoes, fairy cakes, etc. You can use the dual heat mode cooking method without setting your Halo+ Health Fryer into the fully tilted position. The recipes in these instructions will give you more details on which method is best.

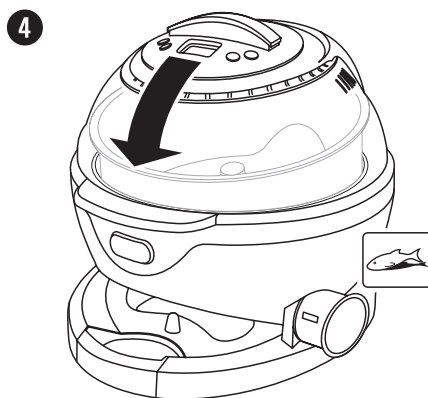
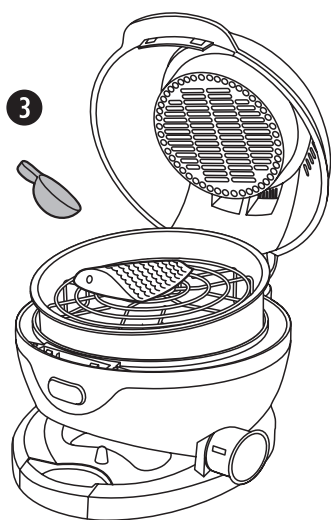
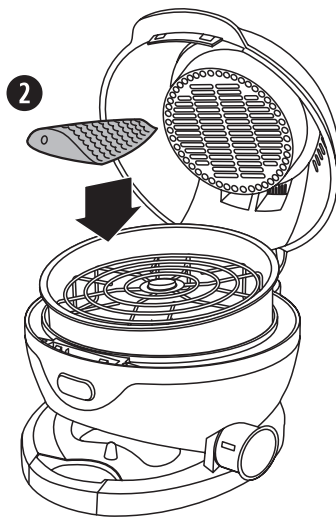
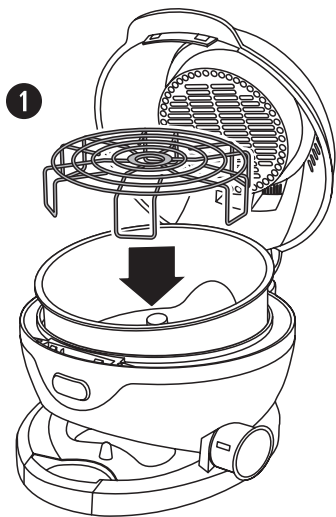



Using your Halo+ Health Fryer to cook food will help you to reduce the amount of oil needed in some recipes, which may benefit your diet.

The table below lists some of the more widely available, popular oils. All of them can be used in your Halo+ Health Fryer. However, for best results, we recommend Vegetable or Rapeseed oil.

Oil Type	Use
Vegetable oil	Shallow, deep and stir frying.
Rapeseed oil (often called vegetable oil)	Shallow, deep and stir frying.
Corn oil	Shallow, deep and stir frying.
Sunflower oil	Shallow, deep and stir frying.
Olive oil	Shallow and stir frying. Marinades, dressings, drizzling.
Sesame oil	Shallow, deep and stir frying. Marinades, drizzling.
Peanut oil (often called ground nut oil)	Shallow and stir frying. Dressings. Adds a nutty flavour.
Grape Seed oil	Shallow, deep and stir frying.

- You can also use low calorie cooking spray in your Halo+ Health Fryer
- Always ensure that the ingredients are evenly coated with oil.



There is nothing quite like a plate of homemade chips—especially with your Halo+ Health Fryer doing all the hard work for you.

There are hundreds of varieties of potatoes grown around the world with about 80 different varieties grown commercially in the UK. Potatoes are usually divided into two categories:

Floury potatoes – These are generally lighter in colour, with a drier feel, perfect for homemade chips and jacket potatoes. Well known varieties are King Edward, Maris Piper and Rooster.

Waxy potatoes – These are moist, firm and translucent and hold their shape well—great in salads. Examples of these include Charlotte and Jersey Royals.

When choosing potatoes for our recipes, it's worth buying the right type to achieve the best results. Many potatoes can be used for a variety of purposes. For example, the King Edward potato can be used for homemade chips.

Usage	Variety
Homemade chips, cajun-style potatoes, roast potatoes	Maris Piper, King Edward, Sante, Rooster, Romano
Jacket potatoes	Maris Piper, King Edward

cooking popular, convenience and frozen foods

The following table provides basic cooking guidelines for popular, convenience and frozen foods. Please note that due to the variations in thickness and size of the foods being cooked some experimentation may be required for the best cooking results. Always ensure that the food is thoroughly cooked and piping hot throughout before consuming.

When cooking fresh chips, we've kept the oil quantities as low as possible for the healthiest results. However, if you feel the chips are a little pale and require further browning, increase the quantity of oil slightly.

Food	Cooking Time (mins)	Notes	Roasting rack	GRILL Mode	DUAL HEAT Mode	Tilted ⁽¹⁾	Oil 
1.25kg fresh chips	40	Wash and pat dry	-	-	YES	YES	1
1.0kg fresh chips	35-40	Wash and pat dry	-	-	YES	YES	½
800g fresh chips	25-30	Wash and pat dry	-	-	YES	YES	½
500g fresh chips	25-30	Wash and pat dry	-	-	YES	YES	¼ - ½
250/300g fresh chips	18-20	Wash and pat dry	-	-	YES	YES	¼
1.0kg fresh wedges	35-40	Wash and pat dry	-	-	YES	YES	½
1.0kg frozen chips	20-25	-	-	-	YES	YES	-
500g frozen chips	15-20	-	-	-	YES	YES	-
250/300g frozen chips	12-15	-	-	-	YES	YES	-
250g jacket potato	60	Prick with a fork and lightly rub with oil	-	-	YES	NO	-
Salmon fillet	15-20	Lightly oil grill rack	YES	YES	-	NO	-
Boneless, skinless chicken fillet	15-20	Lightly oil grill rack. Turn once.	YES	YES	-	NO	-



Food	Cooking Time (mins)	Notes	Roasting rack	GRILL Mode	DUAL HEAT Mode	Tilted ⁽¹⁾	Oil 
Sirloin steak	8-10 ⁽²⁾ 10-12 ⁽³⁾ 15-20 ⁽⁴⁾	Lightly oil grill rack. Turn once.	YES	YES	-	NO	-
Premium ⁽⁵⁾ Sausages	10-12 ⁽⁶⁾	Turn once.	YES	YES	-	NO	-
Bacon	12-15	Turn once.	YES	YES	-	NO	-
Cheese on toast	5-7	Toast the bread in a toaster first.	YES	YES	-	NO	-
Fish fingers	10-12	Lightly oil grill rack. Turn once.	YES	YES	-	NO	-
Frozen pizza	10-12	Cut into slices to fit rack.	YES	YES	-	NO	-
Individual frozen pies	25-30	Place directly into the inner bowl	-	-	YES	NO	-
Fresh garlic baguette	8-10	Cut in half. Place directly into the inner bowl.	-	-	YES	NO	-

- (1) Shows whether to place your Halo+ Health Fryer in the fully tilted position (YES) or in the level position (NO).
- (2) Cooked rare
- (3) Cooked medium rare
- (4) Cooked well done
- (5) E.g. high meat content
- (6) Depending on thickness



▲ Always unplug your Halo+ Health Fryer and allow it to cool completely before cleaning it. NEVER immerse the MAIN body, power cord or plug in water or any other liquid. Never use harsh abrasive cleaners or cleaning materials.

- Carefully wipe any oil spatter from the heater/fan assembly cover with kitchen paper. Wipe over the outer body and lid with a clean, slightly damp cloth and dry.
- Wash the removable clear lid, roasting rack, cooking oil measure, inner bowl, drip tray and bowl handle warm soapy water using a cloth, sponge or brush. Dry completely before use or storage. The roasting rack, cooking oil measure, drip tray and inner bowl may be washed in a dishwasher.

To remove the clear lid:

1. Press the two green lid release buttons (one on each side).
2. Lift off the clear lid.
3. To refit the lid, position the lid over the tongue on the top of the body as shown then pivot the lid into place until the locks on each side click.

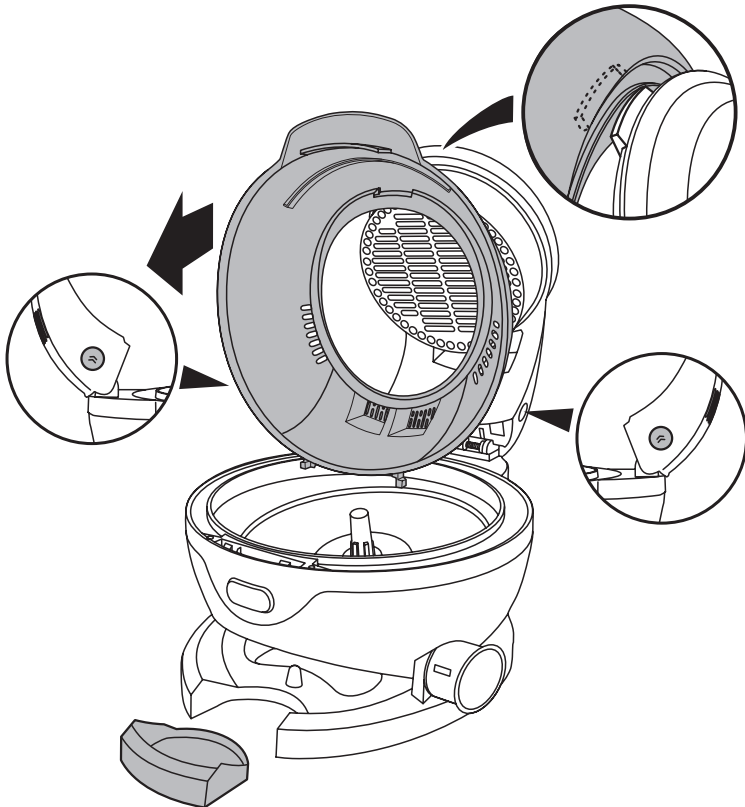



General

For a guide to cooking popular, convenience and frozen foods, see page 14-15.



When necessary, this symbol  will show you how much oil to add using the supplied oil measure.

This symbol  indicates that the recipe is suitable for vegetarians.

Cooking methods used in these recipes.



Dual Heat mode with Fan

Recipes marked with the  icon use the dual heat mode feature of your Halo+ Health Fryer. Dual heat mode cooking uses an additional heating element placed below the bowl along with the top heating element and fan above the bowl to ensure efficient, even heat distribution.

1. Set the timer according to the recipe.
2. Set your Halo+ Health Fryer into the **TILTED** or **LEVEL** position according to the recipe. To tilt your Halo+ Health Fryer, pull the tilt mechanism lock outwards and tilt your Halo+ Health Fryer forwards. Release the tilt mechanism lock to hold your Halo+ Health Fryer in the fully tilted position. When in the tilted position, the  icon will show in the window of the tilt lock. Many recipes will use dual heat mode with your Halo+ Health Fryer in the level position. When in the level position, the  icon will show in the window of the tilt lock.
3. Press the dual heat mode () button to start cooking.
4. Once cooking has finished, if your Halo+ Health Fryer is in the tilted position, release the tilt mechanism lock and return the unit to the level position. Use the clip-on handle to remove the inner bowl.



Grill mode with Fan

Recipes marked with the  icon use the grill mode feature of your Halo+ Health Fryer. Grill mode cooking uses the top heating element and fan only.



1. Set the timer according to the recipe.
2. Make sure that your Halo+ Health Fryer is in the **LEVEL** position. When in the correct level position, the  icon will show in the window of the tilt lock.
3. Press the GRILL mode () button to start cooking.
4. Once cooking has finished, remove the inner bowl using the clip-on handle.

recipes - side dishes and snacks



Perfect Homemade Chips (serves 4)

- 800g of potatoes (floury potatoes such as Maris Piper or King Edward are the best)
 - ½  of vegetable oil
 - Salt to serve
1. Peel the potatoes and chip them into approximately 11-13 mm wide chips with a sharp knife.
 2. Rinse them twice to remove the starch and completely cover them with water until you are ready to cook them.
 3. When you are ready to cook them, drain the chips and pat them dry to remove the excess moisture.
 4. Place the chips into the inner bowl and drizzle with the vegetable oil.
 5. Set the timer for 25 to 30 minutes and cook on the dual heat mode setting with your Halo+ Health Fryer in the TILTED () position until they are golden and crisp.
 6. Sprinkle the chips with salt if required and serve hot.

Cajun-Style Potatoes (serves 4)

- 800g of small potatoes, skins left on but well washed
 - 1  of olive oil
 - 1 clove garlic, chopped
 - 1  of Cajun spices
 - Salt and freshly ground black pepper
1. Cut the potatoes into halves, using a sharp knife. Rinse them twice to remove the starch then completely cover with water until you are ready to cook them.
 2. When you are ready to cook them, drain and pat the potatoes dry with kitchen paper.
 3. Coat them with the oil, Cajun spices and the chopped garlic.
 4. Set the timer for 35 to 40 minutes and cook on the dual heat mode setting with your Halo+ Health Fryer in the TILTED () position until they are golden and crisp.

Perfect Roasted New Potatoes (serves 4)



- 800g new potatoes, halved but with the skins still on
 - 1  of olive oil
 - Salt and Pepper
1. Place the new potatoes into the bowl and drizzle over the oil. Season.
 2. Set the timer for 35 to 40 minutes and cook on the dual heat mode setting with your Halo+ Health Fryer in the TILTED () position until they are golden and crisp.



Cheesy Nacho's with Spicy Tomato Salsa

- 1 large bag of plain nachos
 - 100g of cheddar cheese
 - ½ green chill, deseeded and sliced
 - Sour cream, salsa and Guacamole to serve
1. Evenly scatter the nachos over the bottom of the inner bowl.
 2. Sprinkle the nachos with cheese and the green chilli
 3. Set the timer for 5 minutes and cook on the dual heat mode setting with your Halo+ Health Fryer in the LEVEL () position until the cheese has melted.
 4. Serve the nachos topped with the spicy tomato salsa, sour cream and guacamole.



Stuffed Jacket Potatoes with Sweetcorn and Peppers (serves 4)

- 2 medium jacket potatoes, cleaned with the skins still on
 - 50g strong cheddar cheese, grated
 - 50g sweetcorn
 - 50g finely diced mixed peppers
 - 15g butter or low-fat spread
 - Salt and Pepper
 - Small handful of fresh herbs, such as basil or thyme.
1. Prick the potatoes all over and rub them with a little oil to coat.
 2. Set the timer for 55-60 minutes and cook on the dual heat mode setting with your Halo+ Health Fryer in the LEVEL () position until the potatoes are soft when they are squeezed.
 3. Carefully slice the cooked potatoes in half lengthways. Wear oven gloves and be careful not to tear the skin.
 4. Remove the potato from the skins using a spoon and add to a large mixing bowl. Set the potato skins to one side.
 5. Add the butter, sweetcorn, peppers, herbs and ¾ of the cheese to the mixing bowl. Use a fork to combine the mixture then season.
 6. Spoon the mixture back into the potato skins and sprinkle with the remaining cheese
 7. Gently place the potatoes back into the bowl and cook for a further 15 minutes on the dual heat mode setting with your Halo+ Health Fryer in the LEVEL () position until the cheese turns crispy and golden.

Delicious served with a fresh, crispy salad and coleslaw.



recipes - side dishes and snacks

Stuffed Jacket Potatoes with Antipasto and Pancetta (serves 4)

- 2 medium jacket potatoes, cleaned with the skins still on
 - 60g soft cheese flavoured with garlic and herbs
 - 10g grated parmesan
 - 1 chargrilled pepper finely sliced (these can be bought ready cooked in jars)
 - 3 pancetta rashers, cooked until crisp, crumbled
 - Salt and pepper
 - Pesto (optional)
1. Prick the potatoes all over and rub them with a little oil to coat.
 2. Set the timer for 55-60 minutes and cook on the dual heat mode setting with your Halo+ Health Fryer in the LEVEL  position until the potatoes are soft when they are squeezed.
 3. Carefully slice the cooked potatoes in half lengthways. Wear oven gloves and be careful not to tear the skin.
 4. Remove the potato from the skins using a spoon and add to a large mixing bowl. Set the potato skins to one side.
 5. Using a fork break down the potato adding the soft cheese, chargrilled pepper, pancetta and seasoning.
 6. Spoon the mixture back into the potato skins and sprinkle with the remaining cheese
 7. Top with the grated parmesan and cook for a further 15 minutes on the dual heat mode setting with your Halo+ Health Fryer in the LEVEL  position until golden and piping hot.

Serve drizzled with pesto (optional).

Roasted Mediterranean Vegetables (serves 4)

- 1 small aubergine, diced
 - 2 courgettes, thickly sliced or diced
 - 1 medium carrot, diced
 - 1 large red onions, cut into chunks
 - 1 red pepper, diced
 - 100g button mushrooms, wiped
 - 1 tsp dried mixed herbs
 - 1 large clove garlic, finely chopped
 - ½  of honey
 - 1  of olive oil
 - Salt and pepper
1. Place the vegetables into the inner bowl along with the garlic and herbs. Drizzle over the oil and honey.
 2. Set the timer for 25-30 minutes and cook on the dual heat mode setting with your Halo+ Health Fryer in the TILTED  position.

Delicious served with some oven baked fish or our Parmesan Crusted Salmon.



Roasted Root Vegetables (serves 4)

Perfect as an accompaniment to your Sunday roast The vegetables should be cut to a similar size. For those vegetables where only half is required, why not use up the extra half in a tasty homemade soup.

- 2 medium carrots, peeled, halved lengthways and cut into chunks
- 2 parsnips, peeled, halved lengthways and cut into chunks
- ½ small butternut squash, de-seeded, peeled and cut to a similar size as above
- ½ small celeriac, peeled and cut as above
- 1 tsp cumin seeds, ground
- 1 tsp ground coriander
- 1  of vegetable oil
- Salt and pepper



1. Place the vegetables into the inner bowl and drizzle with the oil. Add the spices, salt and pepper and stir well to combine.
2. Set the timer for 30-35 minutes and cook on the dual heat mode setting with your Halo+ Health Fryer in the TILTED () position.

Serve with your favourite roast meat or grilled chicken for an alternative to your usual vegetables.

For an extra spicy twist, drizzle with a little runny honey and a scattering of dried crushed chilli.



recipes - fish and seafood dishes

Breaded Haddock Goujons with Lemon Mayonnaise (serves 3-4)

- 3 boned haddock fillets, skins removed
 - 200g white bread crumbs
 - 75g plain flour
 - Salt and freshly ground pepper
 - 2 eggs, beaten
 - 2 tbsp of fresh chopped parsley
 - 1  of sunflower oil
 - 300ml mayonnaise
 - 3 tsp of lemon juice
 - 2 tsp of finely grated lemon zest
 - 1 clove garlic, crushed
1. Using a sharp knife, carefully slice the haddock fillets into 2cm wide strips.
 2. Place the bread crumbs, eggs and flour separately into individual dishes, season the flour and sprinkle the bread crumbs with the herbs.
 3. Place the haddock goujons into the flour dish and toss until coated, shake off the excess flour and then dip them into the beaten egg. Next, toss the goujons in the bread crumbs until completely coated.
 4. Flatten the goujons carefully on a flat surface using the palm of your hand.
 5. Place the goujons into the bowl and drizzle over the oil. Cook on the dual heat mode setting for 15-20 minutes with your Halo+ Health Fryer in the LEVEL () position. Turn the goujons half way through cooking.
 6. To make the lemon mayonnaise, mix the mayonnaise with the lemon juice, lemon zest and garlic. Spoon into a suitable serving dish.
- Serve the goujons with the mayonnaise dip and a salad of your choice.



Baked Salmon with a Parmesan Crust (serves 2)

- 2 salmon fillets, boned
 - 2 slices of bread, 1 or 2 days old is the best
 - 1 clove of garlic
 - 50g parmesan cheese
 - 20g soft spread (low-fat margarine, etc.)
 - 1 tbsp of fresh basil
 - 1 tbsp of fresh parsley
 - Salt and freshly ground black pepper
1. Insert the roasting rack into your Halo+ Health Fryer. Lightly oil the rack.
 2. Place the bread, garlic, parmesan cheese and herbs into a food processor or mini chopper and process into a fine bread crumb consistency. Rub or pulse in the soft spread, season.
 3. Place the salmon fillets onto the grill rack, skin side down, and lightly brush with olive oil.
 4. Set the timer for 10-15 minutes (depending on the thickness of the fillets) and cook on the dual heat mode setting with your Halo+ Health Fryer in the LEVEL  position.
 5. Open the lid and cover the top of each salmon fillet with the bread crumb mixture.
 6. Set the timer for 5-10 minutes and cook on the dual heat mode setting with your Halo+ Health Fryer in the LEVEL  position until the topping is golden.
- Delicious served with our Roasted Mediterranean Vegetable recipe

recipes - chicken dishes

Prosciutto Wrapped Chicken (serves 2)

- 2 chicken breasts, skin removed
 - Zest of one lemon
 - 4-6 slices of prosciutto
 - 1tsp fresh thyme
 - ½ garlic clove, finely chopped
 - Olive oil
1. Insert the roasting rack into your Halo+ Health Fryer. Lightly oil the rack.
 2. Place each chicken breast between cling film and use a rolling pin to gently beat the breast until it is evenly flattened to about 2cm thick.
 3. Remove the flattened chicken breast from cling film and drizzle with a little olive oil. Sprinkle with the garlic, lemon zest and a pinch of the fresh thyme.
 4. Wrap the prosciutto carefully around the breast so that the join is underneath and the whole breast is wrapped in the ham.
 5. Lightly oil the chicken and carefully place it onto the rack with the join of the ham on the underside.
 6. Set the timer for 20-25minutes and cook on the dual heat mode setting with your Halo+ Health Fryer in the LEVEL  position. Carefully turn the chicken over half way through the cooking cycle.



Delicious served sliced on the diagonal with some freshly cooked pasta drizzled with pesto. Garnish with torn basil leaves and ground black pepper.



Thai Green Chicken Curry (serves 4)

- 1 small onion, thinly sliced
- 1 stalk lemongrass
- 3-4 tsp Green Thai curry paste
- 3 boneless and skinless chicken breasts, cut into bite-size pieces
- 1 tbsp fish sauce
- 1 tsp brown sugar
- 4 freeze-dried Kaffir lime leaves (optional)*
- 400ml can coconut milk
- 20g pack fresh coriander
- ½  of vegetable oil





*Kaffir lime leaves are now widely available in most good supermarkets.

1. Very finely slice the lemongrass, starting at the thinner end and stopping towards the base when it gets tough (often described as 'woody' and white in the centre).
2. Place the sliced onion and chopped lemongrass in the inner bowl. Drizzle with the vegetable oil. Set the timer for 5 minutes and cook on the dual heat mode setting with your Halo+ Health Fryer in the TILTED () position until the onions begin to soften. Add the chicken pieces and the Thai paste and cook for a further 5-6 minutes.
3. Place your Halo+ Health Fryer into the LEVEL () position. Add the fish sauce, sugar, kaffir lime leaves and coconut milk and carry on cooking for a further 15 minutes until the chicken is cooked through. Open the lid and stir occasionally.
4. While the chicken is cooking, strip the leaves from the coriander stalks, gather into a pile and roughly chop. Taste the curry and adjust the seasoning. Stir half the coriander into the curry and sprinkle the rest over the top.

Delicious served with Thai, jasmine or basmati rice.



recipes - chicken dishes

Creamy Chicken Korma (serves 4)

- 3 chicken breasts, cubed
 - ½  of olive oil
 - 1 onion, finely chopped
 - 2 cloves of garlic, finely chopped
 - 1cm piece of ginger, finely chopped
 - ½  of Garam Masala
 - 200ml chicken stock
 - 100ml coconut milk
 - 1 heaped  of toasted sliced almonds
 - Chopped fresh coriander
1. Place the chicken pieces into the inner bowl and drizzle with the olive oil.
 2. Set the timer for 35 minutes and cook on the dual heat mode setting with your Halo+ Health Fryer in the TILTED () position.
 3. After approx 10 minutes, add the onion, garlic, ginger and garam masala and cook for a further 10 minutes. Stir halfway through.
 4. Place your Halo+ Health Fryer into the LEVEL () position. Add the stock, coconut milk and almonds, stir well and continue to cook for the remainder of the time, occasionally stir.
 5. Sprinkle with the coriander and serve with steamed rice and warm Naan bread.









Swedish-style Meatballs in Tomato Sauce (serves 4)

- Vegetable oil
 - 1 medium onion, grated
 - 1 tsp dried mixed herbs or oregano
 - Pinch ground cumin
 - 1 clove of garlic, finely chopped
 - 500g pork mince
 - 1 egg yolk
 - ½  plain flour
 - Salt and freshly ground black pepper
 - For the tomato sauce
 - 1 clove garlic, finely chopped
 - 1 x 500g carton Passata or chopped tomatoes
 - Salt and pepper to taste.
1. Place the onion, herbs, cumin, garlic, pork, egg yolk and seasoning into a bowl. Mix all the ingredients together using your hands.
 2. Sprinkle over the flour and continue mixing with your hands gathering all the mixture together into the centre of the bowl.
 3. Break off small walnut-sized amounts of the mixture and roll into balls between floured hands. Place the meatballs onto a clean plate. Repeat until you have used all the mixture.
 4. Place the meatballs into the inner bowl and drizzle over the oil.
 5. Set the timer for 15 minutes and cook on the dual heat mode setting with your Halo+ Health Fryer in the LEVEL  position. Carefully turn the meatballs over half way through the cooking cycle.
 6. Once the meatballs are cooked, add the tomato sauce ingredients to the inner bowl and cook for a further 10-15 minutes cook on the dual heat mode setting with your Halo+ Health Fryer in the LEVEL  position until cooked through and bubbling. Stir occasionally.

Delicious served with hot buttered pasta and some buttery cabbage leaves.

recipes - beef and lamb dishes

Creamy Steak Stroganoff (serves 4)

- 1  of olive oil
 - 1 lb of lean frying steak thinly cut into strips,
 - 1 onion, finely diced
 - 1 clove of garlic, finely chopped
 - 100g button mushrooms, finely sliced
 - 1  brandy
 - ½  of Worcestershire sauce
 - 150ml hot beef stock
 - ½  of Dijon mustard
 - ½  of freshly chopped parsley
 - 30g plain flour
 - 110ml soured cream
1. Set the timer for 35 minutes.
 2. Place the steak strips into the inner bowl, drizzle with the oil and cook on the dual heat mode setting for 10 minutes with your Halo+ Health Fryer in the TILTED () position.
 3. Add the onions, garlic and mushrooms, stir and cook for a further 10 minutes.
 4. Add the brandy, stir and allow to cook for a further few minutes until bubbling away.
 5. Place your Halo+ Health Fryer into the LEVEL () position. Sprinkle the flour over the mixture then add the mustard, Worcestershire sauce and stock and stir to combine.
 6. Allow to cook for the remainder of the cooking time (approx. 10 minutes).
 7. Season if required, then stir in the cream.

Serve with freshly cooked pasta or creamy mashed potato.



Beef and Caramelized Red Onion Burgers (makes 4)

- 400g of good quality minced beef
- 1 small red onion, finely chopped
- 1 tsp of brown sugar
- 1 tsp of dried mixed herbs
- 1 egg, beaten
- Handful of coriander leaves, chopped

To serve: Bread rolls, cheese slices, sliced tomatoes, lettuce and ketchup

1. In a frying pan gently sauté the chopped red onion on a low/medium heat with the olive oil and brown sugar for 5 minutes. Remove from the heat and set aside to cool.
2. Work the mince together in a bowl with the caramelized onions and the beaten egg. You want to combine the mixture so that all the ingredients are mixed but don't make it too mushy and soft.
3. Stir in the chopped coriander and the dried herbs. Season to taste.
4. Take a handful of the mixture and form it into a burger shape. The mixture should make about 4 burgers. The thicker they are, the longer they will take to cook through.
5. Lay each burger on a board that has been covered in cling film and then cover them.
6. Put them in the fridge to chill for approximately 1 hour. This will help them to maintain their shape while cooking.
7. When you are ready to cook the burgers, place them onto the lightly oiled roasting rack.
8. Cook for 15-20 minutes on the grill mode setting with your Halo+ Health Fryer in the  LEVEL position carefully turning them over half way through the cooking cycle.

Serve the burgers on the bread rolls with cheese, tomato, lettuce and ketchup.



Spicy Lamb Burgers (makes 4)

- 400g of lean lamb mince
- ½ red onion, finely chopped
- 1 egg, beaten
- 1 tablespoon of mango chutney
- Handful of fresh coriander leaves, chopped
- ½ red chilli, deseeded and chopped
- 1 garlic clove, crushed
- ½ tsp of cumin
- ½ tsp of ground coriander

To serve

- 4 mini Ciabattas
 - Mint, chopped
 - Thick greek yogurt
 - 1 cucumber, finely chopped
1. In a frying pan, gently sauté the chopped red onion on a low/medium heat with a splash of vegetable oil until softened. Set aside to cool.
 2. In a bowl work together the lamb mince with the beaten egg.
 3. Stir in the cooked onion, mango chutney, coriander leaves, chilli, garlic and the spices.
 4. Work the mixture together using your hands then pat the mixture into burger shapes.
 5. Place them on a cling film lined tray and cover. Chill them in the fridge for about 1 hour.
 6. Lightly oil the roasting rack. Place the burgers onto the rack and brush with olive oil.
 7. Cook for 15-20 minutes on the grill mode setting with your Halo+ Health Fryer in the LEVEL () position carefully turning them over half way through the cooking cycle. Check that the burgers are thoroughly cooked through.
 8. In a separate bowl, mix together the Greek yogurt, chopped cucumber and the mint.
 9. Place the ciabatta under a grill for 1-2 minutes until it is lightly toasted. Serve the lamb burgers on the Ciabatta topped with the lettuce and yogurt dressing.



Vegetable Burgers (makes 4)



- 400g canned chickpeas, drained and rinsed
- 1 medium onion, grated
- 1 medium carrot, grated
- 1 red chilli, finely chopped
- 5cm (2 inch) piece fresh ginger, grated
- bunch fresh coriander, roughly chopped
- 1 medium egg, beaten
- 2 tbsp fresh breadcrumbs
- Vegetable oil
- 4 burger buns

To serve

- tomato ketchup, mustard, fried onions and coleslaw
1. In a large bowl, mash the chickpeas with a fork until smooth (or process using a hand blender). Add the onion, carrot, chilli, ginger and chopped coriander and mix together well until combined. If you are using a hand blender, a few pulses combines this mixture perfectly.
 2. Add the beaten egg and breadcrumbs and mix together well. Season with a little salt and pepper to taste.
 3. Divide the mixture equally into four portions. Roll each portion into balls about the size of a tennis ball. Flatten slightly into patties about 2cm thick using the palms of your hands. Make sure all the burgers are the same thickness.
 4. Transfer the burgers to a plate, cover with cling film and chill in the fridge for 30-60 minutes.
 5. Lightly brush the roasting rack with vegetable oil and carefully place the burgers on top. Brush the burgers with a little vegetable oil then cook on the grill mode setting with your Halo+ Health Fryer in the LEVEL  position for about 15 minutes carefully turning half way through cooking.
 6. To serve, slice the buns in half and place one burger inside each. Top with your choice of accompaniment.



Goats Cheese Stuffed Mushrooms (serves 4)

- 4 large flat mushrooms
 - 1½  of olive oil
 - 1 red onion, finely chopped and lightly cooked till softened
 - 6 tablespoons of white bread crumbs
 - 1 clove of garlic, crushed
 - 75g of goat's cheese, crumbled
 - 1 tbsp toasted pine nuts
 - 1 tbsp freshly chopped parsley
 - Freshly ground black pepper
1. In a bowl, mix together half of the oil with the onions, bread crumbs, parsley, garlic, pine nuts, crumbled goat's cheese and some freshly ground pepper.
 2. Place the mushrooms upside down onto the lightly oiled roasting rack and spoon the goat's cheese mixture into them. Drizzle with the remaining oil and cook for approx 15-20 minutes on the dual heat mode setting with your Halo+ Health Fryer in the LEVEL () position.



Individual Cup cakes (makes 8 cooked in 2 batches)

- 100g softened butter or margarine
 - 100g caster sugar
 - 2 eggs
 - Few drops of vanilla essence
 - 100g self raising flour
 - ½ tsp baking powder
1. Place all the ingredients into a bowl and use a hand mixer to whisk all the ingredients together until a light creamy mixture is achieved.
 2. Fill 6-8 silicone cupcake moulds half full with the cake mixture.
 3. Place the cakes inside the inner bowl and close the lid. Set the timer for 11 minutes and cook on the dual heat mode setting with your Halo+ Health Fryer in the LEVEL  position.
 4. Once cooked, carefully remove the inner bowl and place it onto a roasting rack to cool.
 5. After 5 minutes remove the cakes from the inner bowl and cool them for a further 15 minutes on the roasting rack before decorating.

Tip: To stop your cakes from sliding around the inner bowl, cut out a piece of foil roughly the same size as the bowl. Make a slit in the centre and slide the foil over the inner bowl's central shaft. Sit your cakes on top of the foil and this will stop them sliding about.

Warm Tropical Fruit Salad

- 100ml of tropical juice
 - 30g of golden caster sugar
 - 1 teaspoon of vanilla extract
 - 1 orange, zested
 - 2 passion fruits (pulp and seeds)
 - 1 ripe mango, peeled and de-stoned
 - 1 pineapple, prepared
 - 1 kiwi, peeled, cut into chunks
 - 2 ripe peaches or nectarines, de-stoned
1. Have a bowl of iced water ready.
 2. Heat the tropical juice, sugar, vanilla, orange zest and passion fruit until the sugar has dissolved in a small pan on a low to medium heat. Quickly place the pan into the cold water so that the mixture forms a syrup.
 3. Cut the prepared fruit into slices. It is attractive to cut the pineapple into rings, the peaches or nectarines into segments and the mango into wedges but you can prepare the fruit any way you like.
 4. Place the fruit in the bowl and coat it with the syrup. Cook for approximately 5-8 minutes on the dual heat mode setting with your Halo+ Health Fryer in the LEVEL  position until softened and juicy.
Delicious served warm over pancakes with ice cream.



Baked peaches with Amaretti biscuits (serves 2)

if you have a food processor, why not use this to chop up your biscuits and nuts!

- 40g toasted hazelnuts, roughly chopped
 - 40g amaretti biscuits, crushed
 - 25g unsalted butter, room temperature (soft spread can also be used as a substitute)
 - 15g caster sugar
 - 1 free-range egg yolk
 - ½ lemon, juice only
 - 2 ripe peaches or nectarines
 - 1 tsp lemon zest
 - 2 tbsp thick cream
 - 2 sprigs fresh mint (optional)
 - Icing sugar (optional)
 - Raspberries (optional)
1. Mix the hazelnuts, biscuits, butter, sugar, and egg yolk in a bowl until the ingredients hold together as a rough paste.
 2. Cut each peach in half, remove the stone and pack a rounded spoonful of the filling onto each half. This should fill the cavity in the peach and cover most of the exposed half of the fruit.
 3. Place the halves onto the lightly oiled roasting rack. Cook for about 10-15 minutes on the dual heat mode setting with your Halo+ Health Fryer in the LEVEL  position until cooked (the cooking time will depend on the ripeness of the fruit).
 4. To serve, place the baked peaches on to serving plates, and place a large dollop of the thick cream alongside it. Optionally, garnish with mint and a handful of fresh raspberries and dust with icing sugar.



connection to the mains supply

⚠ This appliance must be earthed.

This appliance is fitted with either a moulded or rewirable BS1363, 13 amp plug. The fuse should be rated at 13 amps and be ASTA approved to BS1362.

If the fuse in a moulded plug needs to be changed, the fuse cover must be refitted. The appliance must not be used without the fuse cover fitted.

If the plug is unsuitable, it should be dismantled and removed from the supply cord and an appropriate plug fitted as detailed below. If you remove the plug it must not be connected to a 13 amp socket and the plug must be disposed of immediately.

The wires of the mains lead are coloured in accordance with the following code:

GREEN/YELLOW = EARTH BLUE = NEUTRAL BROWN = LIVE

The wire which is coloured GREEN/YELLOW must be connected to the terminal in your plug which is marked with an E or by the earth symbol (\perp) or coloured GREEN or GREEN /YELLOW.

The wire which is coloured BLUE must be connected to the terminal in your plug which is marked with the letter N or coloured BLACK.

The wire which is coloured BROWN must be connected to the terminal in your plug which is marked with the letter L or coloured RED.

If any other plug is used, a 13 amp fuse must be fitted either in the plug or adaptor or at the distributor board.

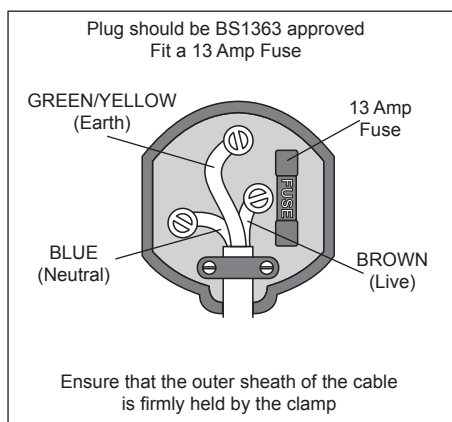



These appliances are built to the very highest of standards. There are no user serviceable parts. Follow these steps if the unit fails to operate:

1. Check the instructions have been followed correctly.
2. Check that the fuse has not blown.
3. Check that the mains supply is functional.

If the appliance will still not operate, return the appliance to the place it was purchased for a replacement. To return the appliance to the Customer Service Department, follow the steps below:

1. Pack it carefully (preferably in the original carton). Ensure the unit is clean.
2. Enclose your name and address and quote the model number (located on the rating label) on all correspondence.
3. Give the reason why you are returning it.
4. If within the guarantee period, state when and where it was purchased and include proof of purchase (e.g. till receipt).
5. Send it to our Customer Service Department at the address below:

**Customer Service Department
Jarden Consumer Solutions (Europe) Limited
Middleton Road
Royton
Oldham
OL2 5LN, UK.
Telephone: 0161 621 6900 Fax: 0161 626 0391
e-mail: enquiriesEurope@jardencs.com**



Replacement parts

For additional or replacement parts, please visit www.breville.co.uk or call us on **0161 621 6900**.

Troubleshooting

For troubleshooting and FAQs visit www.breville.co.uk/faqs

Creative Kitchen

Visit Creative Kitchen for access to the best cooking techniques, mouth-watering meals, entertaining ideas and videos to help take you from part-time cook to expert chef in minutes. Enjoy getting creative with your home cooking at www.brevillecreativekitchen.co.uk.

creative
kitchen



Please keep your receipt as this will be required for any claims under this guarantee.

This appliance is guaranteed for 1 year after your purchase as described in this document.

During this guaranteed period, if in the unlikely event the appliance no longer functions due to a design or manufacturing fault, please take it back to the place of purchase, with your till receipt and a copy of this guarantee.

The rights and benefits under this guarantee are additional to your statutory rights, which are not affected by this guarantee. Only Jarden Consumer Solutions (Europe) Limited (“JCS (Europe)”) has the right to change these terms.

JCS (Europe) undertakes within the guarantee period to repair or replace the appliance, or any part of appliance found to be not working properly free of charge provided that:

- you promptly notify the place of purchase or JCS (Europe) of the problem; and
- the appliance has not been altered in any way or subjected to damage, misuse, abuse, repair or alteration by a person other than a person authorised by JCS (Europe).

Faults that occur through, improper use, damage, abuse, use with incorrect voltage, acts of nature, events beyond the control of JCS (Europe), repair or alteration by a person other than a person authorised by JCS (Europe) or failure to follow instructions for use are not covered by this guarantee. Additionally, normal wear and tear, including, but not limited to, minor discoloration and scratches are not covered by this guarantee.

The rights under this guarantee shall only apply to the original purchaser and shall not extend to commercial or communal use.

If your appliance includes a country-specific guarantee or warranty insert please refer to the terms and conditions of such guarantee or warranty in place of this guarantee or contact your local authorized dealer for more information.

Waste electrical products should not be disposed of with household waste. Please recycle where facilities exist. E-mail us at enquiriesEurope@jardencs.com for further recycling and WEEE information.

Jarden Consumer Solutions (Europe) Limited
5400 Lakeside
Cheadle Royal Business Park
Cheadle
SK8 3GQ
UK

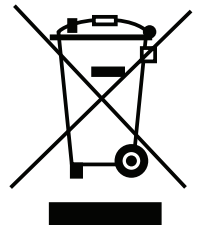





Jarden Consumer Solutions (Europe) Limited
Cheadle Royal Business Park, Cheadle, SK8 3GQ, United Kingdom
e-mail: enquiriesEurope@jardencs.com
Telephone: 0161 621 6900

For Customer Service details, please see the website.

www.breville.co.uk

© 2014 Jarden Consumer Solutions (Europe) Limited

All rights reserved. Imported and distributed by Jarden Consumer Solutions (Europe) Limited,
Cheadle Royal Business Park, Cheadle, SK8 3GQ, United Kingdom.

The product supplied may differ slightly from the one illustrated due to continuing product development.

Printed in China